

BK PRECISION®

Instruction Manual

Models 1785 / 1786 / 1787

PROGRAMABLE DC POWER SUPPLYS

LIMITED TWO YEAR WARRANTY

B&K Precision Corp. warrants to the original purchaser that its product and the component parts thereof. will be free from defects in workmanship and materials for a period of two years from the date of purchase.

B&K Precision Corp. will, without charge, repair or replace. at its option. defective product or component parts. Returned product must be accompanied by proof of the purchase date in the form a sales receipt.

To obtain warranty coverage in the U.S.A.. this product must be registered by completing and mailing the enclosed warranty card to B&K Precision Corp., 1031 Segovia Circle. Placentia. CA 92870 within fifteen (15) days from proof of purchase.

Exclusions: This warranty does not apply in the event of misuse or abuse of the product or as a result of unauthorized alterations or repairs. It is void if the serial number is altered, defaced or removed.

B&K Precision Corp. shall not be liable for any consequential damages. including limitation damages resulting from loss of use. Some states do not allow limitation of incidental or consequential damages, so the above limitation or exclusion may not apply to you.

This warranty gives you specific rights and you may have other rights. which vary from state-to-state.

Model Number: _____

Date Purchased: _____

CONTENTS

1 INTRODUCTION.....	1
2 SPECIFICATIONS.....	2
3 CONTROLS AND INDICATORS.....	4
4 OPERATING INSTRUCTIONS	
General Operation.....	6
Standard Operation Mode.....	7
Timed Operation Mode.....	10
5 PRECAUTIONS FOR USE.....	13
6 USING THE PC INTERFACE.....	14
7 MAINTENANCE.....	16

INTRODUCTION

This unit is a high quality Micro-controller Based DC power supply with a total supply capability of 90W. By using a digital operation control and an analog output control, the unit combines the advantages of ease and accuracy of digital systems with the clean supply and quiet operation of analog systems.

This unit also has the added flexibility of an optional RS-232 (serial port) interface with a PC complete with control software.

In order to gain the greatest benefit from this instrument it is imperative that you read the instruction manual in full before operating the unit.

SPECIFICATIONS

MODEL	1785	1786	1787
Output (DC)	0 - 18V	0 - 30V	0 - 60V
Output Current (Amp.)	5	3	1.5
Ripple & Noise (RMS)	1 mV		
Line Regulation	0.02% + 5mV		
Load Regulation	0.02% + 5mV		
RS - 232	Option		
Operating Voltage	110V, 60Hz (or on request 220-240V)		
Dimension (W.H.D.)	8.07 x 4.53 x 10.63 in. (205 x 115 x 270 mm)		
Accessory Supplied	User Manual		
Weight	App. 11 lbs (5 Kg)		
Display	LED Voltmeter & Ammeter		

SPECIFICATIONS

MODEL	1785	1786	1787
Cooling System	Natural convection		
Power Consumption	Approximate 220 VA / W		Approximate 200 VA / W
Operating ambient temperature	41° to 104°F (5 to 40°C)		10 - 80% R.H.
FUSE RECOMMENDED			
Input fuse F5			
AC100V, 110V, 120V	5 x 20mm	4A	250V Fast Blow
AC220V, 230V, 240V	5 x 20mm	2A	250V Fast Blow
Internal fuse F1	5 x 20mm	0.5A	250V Fast Blow
Internal fuse F2	5 x 20mm	0.5A	250V Fast Blow
Internal fuse F3	5 x 20mm	0.5A	250V Fast Blow
Internal fuse F4	5 x 20mm	0.5A	250V Fast Blow

CONTROLS AND INDICATORS

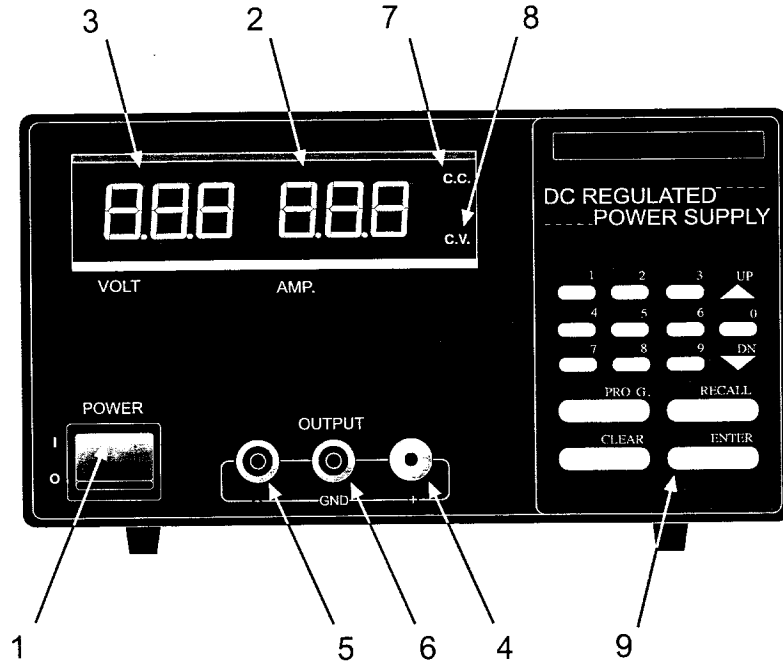

1. POWER SWITCH. Turns power supply on and off.

2. AMMETER DISPLAY. Indicates output current.

3. VOLTMETER DISPLAY. Indicates output voltage.

4. OUTPUT "+" TERMINAL (RED). Positive polarity output terminal.

5. OUTPUT "-" TERMINAL (BLACK). Negative polarity output terminal.

CONTROLS AND INDICATORS

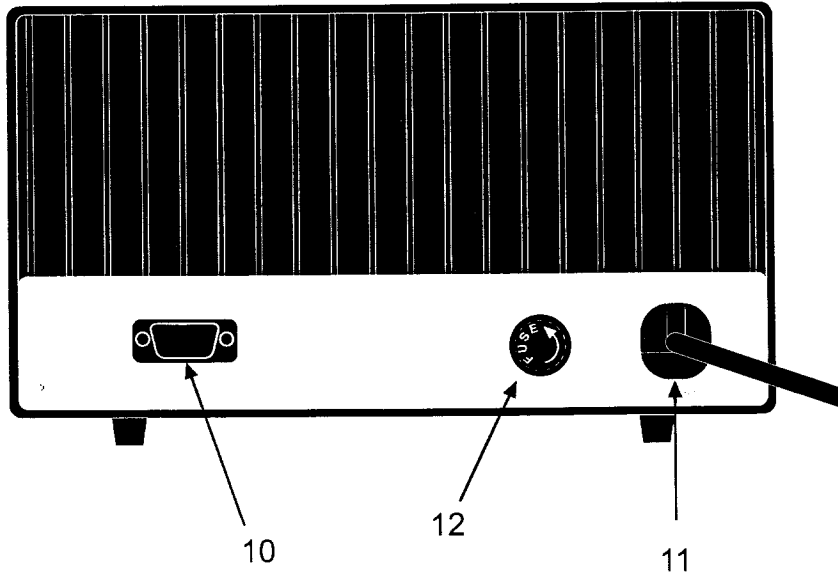

6. GROUND "GND" TERMINAL (GREEN).
Ground terminal connected to chassis.

7. CC DISPLAY. Indicates the unit is
in constant current mode.
(Minute indicator in program mode)

8. CV DISPLAY. Indicates the unit is
in constant voltage mode.
(Second indicator in program mode)

9. KEYPAD.

10. SERIAL PORT. Port for optional
PC interface.

11. MAIN CABLE.

12. FUSE.

OPERATING INSTRUCTIONS

GENERAL OPERATION

After switching on the unit, prior to any power being delivered, the unit will go through its start-up self-diagnostic routine. As the unit carries out its diagnostic routine you will see both displays count from zero to nine.

The unit will now be in standard operation mode and will assume the voltage and ampere settings to those during previous power down.

WARNING

For the above reason do not connect equipment to the unit if you have any doubt as to what its settings were at previous power down.

The unit will always maintain either the maximum set voltage or current within its capability. During operation either the C.V. or C.C. indicator will be illuminated. These indicate whether the unit is running in constant voltage or constant current mode respectively.

This unit has a built in O.V.P (over voltage protection) feature. In the event of the voltage becoming significantly greater than the setting value, the O.V.P. will be triggered. In this instance power delivery will be cut and an **OE-ERR** warning will be displayed. When you get this warning, switch the unit off and remove all loadings. If you then switch the unit back on it should resume normal operation. In the event this problem persists, the unit must be returned to a factory authorized service center.

OPERATING INSTRUCTIONS

STANDARD OPERATION MODE

In Standard operation mode, once the voltage and current have been set, the unit will maintain these settings until reprogrammed.

There are two ways of setting up the unit in standard operation mode, either by manual operation or use of the pre-set setting feature. Both methods are described below:

MANUAL OPERATION

1 Press 'ENTER' key

The left-hand display will show 'S-E' (i.e. set voltage) and the present voltage setting will be shown in the right-hand display.

Set voltage to required level using either the number or up and down keys (If you enter a voltage outside the unit's capability, an error message will be displayed followed by the maximum allowable voltage of the unit. You must re-enter the voltage).

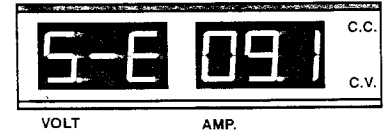

2 Press 'ENTER' key

The left-hand display will show 'S-C' (i.e. set current) and the present current setting will be shown in the right-hand display.

Set the required current level using the keypad (If you enter a current level larger than the unit's capability, an error message will appear followed by the maximum allowable current of the unit. You must re-enter the required current)

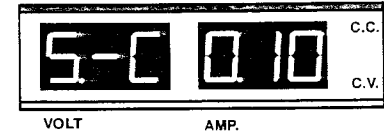

3 Press 'ENTER' and the unit will immediately assume input settings.

The unit will now maintain these settings until it is in some way reprogrammed.

OPERATING INSTRUCTIONS

USING THE PRE-SET FEATURE

The unit has the ability to store nine pre-programmed voltage and current settings. Once programmed these settings will be stored by the unit even when switched off.

PRE-SET PROGRAMMING

1 Press 'PROG.' key

The display will show 'P-'. Input the location of the pre-set (1 to 9) you wish to program.

2 The display will now show 'P' followed by the pre-set location you chose and 'E' (i.e. program pre-set voltage).

Using the keypad set your required voltage then press 'ENTER'.

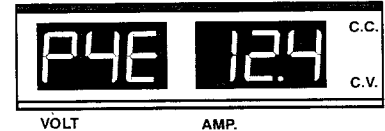

3 The display will now show 'P', pre-set number, 'E' (i.e. program pre-set current).

Set the required current level followed by the 'ENTER' key.

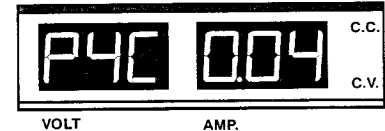

4 The unit will now ask you to set the next pre-set, i.e. 'P', next pre-set, 'E'.

If you do not wish to change these settings press the 'ENTER' key and the unit will retain the current value and advance to the next stage.

If you go through the above, up to the ninth pre-set, when you press 'ENTER' you will get an 'End' message.

The pre-sets have now been successfully programmed.

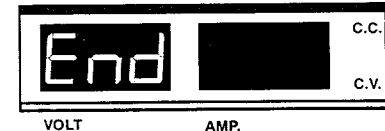

OPERATING INSTRUCTIONS

Whenever you want to terminate programming you can press the 'CLEAR' key to return to normal operation mode. The programmed value for the preceding locations will be retained.

SELECTING PRE-SETS

1 Press 'RECALL' key

The left-hand display will show 'L -'.

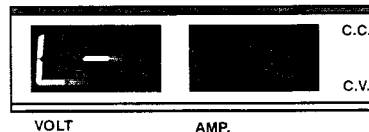

2 Input the pre-set location you wish to use .

The unit will now display the setting for the chosen pre-set and both decimal places will flash.

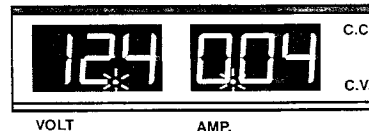

3 Press 'ENTER' .

The unit will immediately assume the chosen pre-set settings.

If during any of the above procedures you fail to input a setting within approximately ten seconds, the unit will cancel that procedure and assume its previous settings. You can exit any of the above operations by pressing the 'CLEAR' key and the unit will assume its previous setting.

In Manual Operation mode the voltage and current can be adjusted using the up and down keys within the units limits at constant voltage mode (C.V.) and constant current mode (C.C.) respectively.

OPERATING INSTRUCTIONS

TIMED OPERATION PROGRAMMING

In the programmable mode the unit can be set to change the voltage and current settings for up to ten pre-set time periods.

Once in the program mode, the unit will loop through the programmed settings for the previously entered cycles unless interrupted by pressing 'CLEAR'.

PROGRAMMING THE UNIT

When programming the unit all ten (□□ to □□) of the unit's addresses must be filled. In the event you require 2 to 9 steps in the cycle program, only set as many addresses as you require. After which, set the time for the remaining addresses to zero. Any address with a time frame of zero will effectively not exist.

Note - as soon as the unit reaches an address with a time frame of zero, it will return to the first address (□□). Therefore always fill in 'empty' addresses from the end (□□) forward.

- 1 Press the 'PROG.' key followed by '0'.**
- 2 The display will now show '□□E' (i.e. set address 0 voltage) and any previous pre-set voltage value.
Set the voltage to the required value and press 'ENTER'.**
- 3 The display will now show '□□C' (i.e. set address 0 current) and the previously programmed value.
Set the current level and press 'ENTER'.**

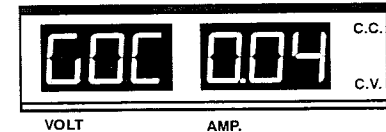

OPERATING INSTRUCTIONS

- 4 The display will now show '00t'** (i.e. set address 0 time) and the 'C.C.' will illuminate to indicate minutes.
Set the number of whole minutes you require (up to a maximum of 99) and press 'ENTER'.

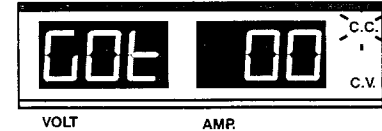

- 5 The display will remain as before, however, the 'C.V.' will illuminate to indicate seconds.**
Set the number of seconds you require (up to a maximum of 59) in addition to the previously set minutes and press 'ENTER'.

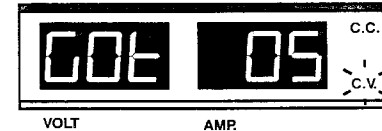

- 6 The left-hand display will now show '1E'** (i.e. set address 1 voltage).
You must now repeat steps **2** to **5** for all 9 remaining addresses.

- 7 After you have pressed 'ENTER', after setting the seconds for the tenth address (No. 9), the display will show 'End'.**
The unit has now been successfully programmed and will return to standard operation mode.

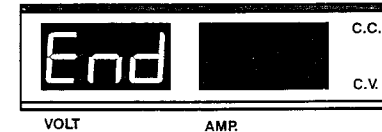

NOTE: Please be aware that the life of the relay will limit the life of the power supply which is 100×10^3 operations as stated by the manufacturer.

OPERATING INSTRUCTIONS

RUNNING A PROGRAMMED SEQUENCE

Once all the addresses have been programmed, as explained in the previous section, to recall the program:

1 Press 'RECALL' followed by the '0' key.

The display will show 'r 0 E' (recalled address 0 voltage) with the corresponding value for address 0.

Using the up and down keys you are now able to move up and down to check all four values for all ten addresses.

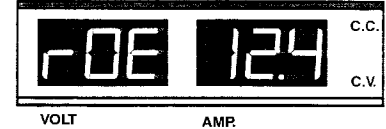

2 Once you are satisfied that all the addresses are correct press 'ENTER'

The display will show 'r u n' and '-- 0'.

Using the up and down keys set the number of cycles you require (0-9, 0 being infinity).

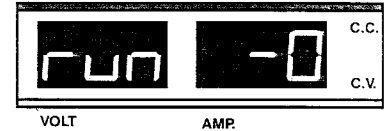

3 Once the number of cycles is set press 'ENTER'.

The unit will run through the program starting with address 0.

You will know the unit is in running-in programmed mode as a dot on the extreme bottom right of the right hand display will flash.

In order to exit the program, press the clear button. The unit will resume in the standard operation mode. The voltage and current settings will be those of the address the unit was up to at the point of exit from the program.

If during any of the above procedures you fail to input a setting within approximately ten seconds, the unit will cancel that procedure and assume its previous settings.

PRECAUTIONS FOR USE

1 CONFIRMING THE SUPPLY RANGE

The units must be used within its specified range. The rated input voltage can be found on the rating label under the unit. Before plugging into the AC supply outlet, check whether the input rating conforms with your local supply . For certain models, a voltage selector is available, please switch the voltage selector to the appropriate position before use.

2 OPERATING ENVIRONMENT

- Use this unit within the specified ambient temperature range listed in the specification table.
- Because the unit is cooled by natural convection, do not place objects on top to block the convection. Also, user must avoid placing the unit on or near any heat emitting devices or using multiple units in stacked configuration. For best results, use the unit in an environment that is as well cross-ventilated as possible.
- At 1KV of fast transient burst environment, the captioned model may have trouble in operation and require user reset.
- At 3V/m radiated immunity environment, the voltmeter may take a reading error +/-2V max. of the captioned model and back to normal operation without the interference.
- Altitude up to 2000M
- Installation category : CAT II
- Pollution degree : 2
- Indoor use only



Warning : For model 1787 , the maximum output voltage is up to 60Vdc. If touching live metal part of output terminal, it may be hazardous. User must avoid to touching live metal part of output terminal.

USING THE PC INTERFACE

In order to use the RS-232 serial port PC interface a separate kit is available as an option to this unit.

The kit comprises both the hardware and software required, along with an additional instruction manual.

Please contact your distributor for more details.

MAINTENANCE

WARNING

This is a factory sealed unit and the only maintenance that can be carried out is described below.

You should under no circumstances remove any of the casing from the unit. In the event that you encounter problems which cannot be solved using the methods described below, then the whole unit must be returned to the agent.

FUSE REPLACEMENT

If the fuse blows, the unit will not operate. Under normal circumstances the fuse should not blow, hence if it does this may indicate some problem with the unit.

Before replacing the fuse remove any loadings from the unit and then only replace with a fuse of the correct rating.

RECALIBRATION

Over a period of time and usage of this unit may require a degree of calibration due to small changes in the operation of the A/D Converters, D/A Converters and operational amplifier.

Within this unit is software which allows you to calibrate both voltage and current outputs without having to open the casing.

MAINTENANCE

CALIBRATING THE UNIT

- While switching on the unit hold down both the no. '1' and '9' buttons on the keypad.

This will gain you access to the calibration mode and the display will show 'CAL'.

Using the up and down keys you can now choose voltage (---E), current (---I), or exit calibration (End). After selecting press 'ENTER'.

If you press 'CANCEL' at any time during calibration you will return to the above menu and no change will be made to the memory.

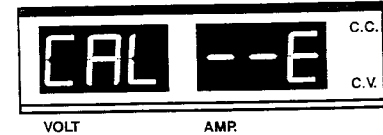

CALIBRATING VOLTAGE

- 1 Connect a voltmeter to the output terminals (see fig. 1).
- 2 Select voltage calibration and the unit will enter SCAN mode.
- 3 Scan through the whole range of output voltage using the 'UP' and 'DOWN' keys.
- 4 Compare the voltage reading of the unit with the voltmeter reading at every step.

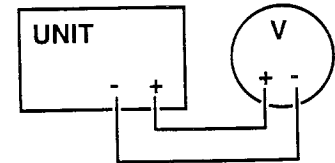

fig. 1

MAINTENANCE

- 5 If the reading is different press 'ENTER' once to enter ADJUSTMENT mode.** Using the up and down keys you will be able to fine tune the voltage until the voltmeter corresponds to the level the unit voltage is set. Press 'ENTER' again to return to the SCAN mode. If the reading is acceptably close press 'ENTER' once more and the unit will display a 'STORE' message shortly after which you will return to the voltage, current, end menu.
- 6 In the event that you scan up to the maximum output voltage and no adjustment is required, press 'ENTER' three times.** The unit will now display a 'STORE' message and return to the voltage, current, end menu.

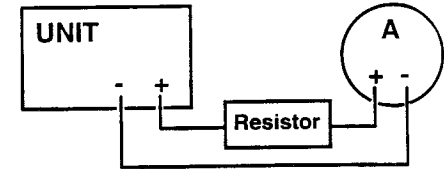

fig. 2

CALIBRATING CURRENT

- 1 Connect a resistor and ammeter to the unit in series** (see fig. 2)
The correct resistor value for specific models can be found in the opposite table (fig. 3).
- 2 Select current calibration and the unit will enter SCAN mode.**
- 3 Enter a voltage across the resistor that will make the unit switch to constant current (C.C.) mode.** Usually, the maximum allowed voltage for the model under test should be entered.
- 4 Scan through the whole range of output current using the 'UP' and 'DOWN' keys.**

MODEL	1785	1786	1787
Resistor	3.6Ohm	10Ohm	40Ohm
Rating	120W	120W	120W

fig. 3

MAINTENANCE

- 5 Compare the current reading of the unit with the ampmeter reading at every step.
- 6 If the reading is different, press 'ENTER' once to enter **ADJUSTMENT mode**. Using the up and down keys you will be able to fine tune the current until the ampmeter closely corresponds to the set current. Press 'ENTER' again to return to the SCAN mode and then go back to step 3 . If no more adjustment is required, just keep on pressing the 'ENTER' key until the 'StorE' message shows up. You will return to the voltage, current, end menu.
- 7 In the event that you scan up to the maximum output current and no adjustment is required, keep on pressing the 'ENTER' key until the 'StorE' message shows up. You will return to the voltage, current, end menu.

EXITING CALIBRATION MODE

Once you have returned to the voltage, current, end menu, select 'End' and press 'ENTER'. The unit will now switch to normal operation mode with the voltage and current settings from the previous power down.

NOTE: For voltage and current calibration, only 10 points for each are allowed. Whenever all the points are used up, the program will exit automatically with the 'StorE' message displayed and shortly after return to the voltage, current, end menu.

SERVICE INFORMATION

Warranty Service: Please return the product in the original packaging with proof of purchase to the below address. Clearly state in writing the performance problem and return any leads, connectors and accessories that you are using with the device.

Non-Warranty Service: Return the product in the original packaging to the below address. Clearly state in writing the performance problem and return any leads, connectors and accessories that you are using with the device. Customers not on open account must include payment in the form of a money order or credit card. For the most current repair charges contact the factory before shipping the product.

Return all merchandise to B&K Precision Corp. with pre-paid shipping. The flat-rate repair charge includes return shipping to locations in North America. For overnight shipments and non-North American shipping fees contact B&K Precision Corp.

B&K Precision Corp.
1031 Segovia Circle
Placentia, CA 92870

Phone: 714-237-9220
Facsimile: 714-237-9214
Email: service@bkprecision.com
Website: www.bkprecision.com

Include with the instrument your complete return shipping address, contact name, phone number and description of problem.