

# INSTRUCTION MANUAL

for

Model 1035

WOW & FLUTTER

METER

**BK** PRECISION DYNASCAN  
CORPORATION

6460 West Cortland Street  
Chicago, Illinois 60635

---

**TABLE OF CONTENTS**

---

	Page		Page
TEST INSTRUMENT SAFETY .....	inside front cover	Line Voltage Selection .....	11
INTRODUCTION .....	1	Preparation for Operation .....	11
FEATURES .....	2	Wow/Flutter Measurement .....	11
SPECIFICATIONS.....	3	Use of Rear Panel Terminals.....	13
CONTROLS AND INDICATORS.....	5	Use as Frequency Counter.....	13
Front Panel Controls .....	5	MAINTENANCE.....	15
Rear Panel Facilities .....	7	Case Removal .....	15
OPERATING INSTRUCTIONS .....	10	Fuse Replacement .....	15
Safety Precautions .....	10	Adjustments.....	15
Equipment Protection Precautions .....	10	Instrument Repair & Calibration Service .....	16
Operating Tips .....	11	WARRANTY SERVICE INSTRUCTIONS.....	18
		LIMITED ONE-YEAR WARRANTY .....	inside rear cover

---

## INTRODUCTION

---

The **B & K-Precision Model 1035 Wow & Flutter Meter** is a precision audio test instrument for measuring wow and flutter of turntables, tape recorders, or other rotating devices. Since this instrument measures wow and flutter as low as 0.003%, it is suitable for checking professional equipment as well as home entertainment products. Six ranges give good resolution for all values from 0.003% to 10%.

There are four primary standards for wow and flutter measurement used in the world - JIS (Japan), NAB (U.S.A.), CCIR (France), and DIN (Germany). This versatile instrument accommodates all four measurements standards by pushbutton selection. In addition, line voltage selection is easily changed to permit operation from 100, 117, 220, or 240 volt 50/60 Hz ac power. These features make the instrument fully international.

Wow and flutter is measured by playing a test record or tape which has been pre-recorded with a continuous 3 kHz (JIS, NAB, or CCIR) or 3.15 kHz (DIN) tone and feeding the audio signal into the instrument. Wow and flutter cause variations of the test tone frequency. The variations are separated from the test tone and measured. The frequency of the test tone is displayed on a built-in four-digit frequency counter and the percentage of wow and flutter is indicated on a large easy-to-read analog meter.

Flutter causes test tone variations of 6 Hz to 200 Hz, while wow causes variations under 6 Hz. Filters separate the wow and flutter components of the signal if desired. Mode

selection permits the user to select measurement of flutter only, wow only, or wow and flutter combined, either weighted or unweighted.

The instrument accommodates a wide range of input signal levels, permitting measurement at nearly any desired point in the equipment under test. There are two selectable sensitivities of 0.5-100 mV and 5 mV-30 V. The high sensitivity position permits measurement of small signals directly from tape heads and phono cartridges if desired. The associated level monitor indicator is a time saving feature for setting up tests. The indicator lights if the input signal level is adequate for wow and flutter measurements; no other measurements or adjustments are required.

Another convenience is the built-in crystal-controlled oscillators which provide very stable sources of 3 kHz and 3.15 kHz for recording wow and flutter test tapes.

Auxiliary output jacks provide outputs to other instruments such as oscilloscopes and chart recorders if desired. These jacks provides a dc voltage proportional to rotational speed error, and both ac and dc voltages proportional the wow and flutter meter reading.

For added versatility, the built-in four-digit frequency counter may be used independently from wow and flutter measurements for general measurement of audio frequencies. The instrument offers selectable crystal controlled or line frequency (50 or 60 Hz) time base. An overflow indicator lights for frequencies higher than 9999 Hz.

---

## FEATURES

---

### WIDE MEASUREMENT RANGE

Measures wow and flutter from 0.003% to 10% in 6 ranges.

### PRECISION MEASUREMENTS

Measure wow and flutter as low as 0.003%. Suitable for use with professional type tape recorders and turntables.

### HIGH SENSITIVITY

Minimum operating input voltage is as low as 0.5 mV, permitting measurement of wow and flutter directly from a small output tape head or phono cartridge.

### WIDE INPUT LEVEL RANGE

Selectable input level in two steps permits measurement of inputs from 0.5 mV to 30 V.

### FOUR MEASUREMENT STANDARDS

Pushbutton selectable measurement standards makes unit fully international. Measures rms values (JIS - Japan), mean values (NAB - U.S.A.) and peak values (CCIR - France and DIN - Germany).

### FOUR MODES

Four pushbutton selectable modes, weighted or unweighted combination of wow and flutter, wow only, or flutter only.

### BUILT-IN WOW & FLUTTER OSCILLATOR

Measures wow and flutter from pre-recorded test record or tape. Built-in oscillator permits recording of wow and flutter

test tape. Selectable 3 kHz (JIS, NAB, or CCIR) or 3.15 kHz (DIN) standards.

### BUILT-IN FREQUENCY COUNTER

Four digit display indicates wow and flutter test frequency (approximately 3000 Hz or 3150 Hz). May be switched to operate as 10 Hz to 9999 Hz frequency counter for measurement of any audio input signal.

### AUTOMATIC LEVEL MONITOR

Indicator lights if input signal level is appropriate. No external measurement of input level required. In frequency counter mode, indicator flickers if count exceeds 9999 Hz as overflow indication.

### CRYSTAL OSCILLATOR STABILITY

Internal 3 kHz and 3.15 kHz oscillators and time base for frequency counter are crystal controlled.

### AUXILIARY OUTPUTS

Three auxiliary output jacks provide ac and dc output voltages for connecting frequency analyzers such as oscilloscope, chart recorder, or digital memory scope. AC voltages proportional to wow and flutter; dc voltages proportional to speed error and wow and flutter.

### UNIVERSAL LINE VOLTAGE

Operates from 100, 117, 220, or 240 volt 50/60 Hz ac power. Simple external changeover.

---

## SPECIFICATIONS

---

### WOW & FLUTTER METER SECTION

#### Measuring Center Frequency:

3 kHz  $\pm$ 300 Hz (JIS, NAB, CCIR).

3.15 kHz  $\pm$ 300 Hz (DIN).

#### Input Sensitivity:

Two ranges; 0.5 mV to 100 mV and 5 mV to 30 V.

#### Wow & Flutter Measurement Range:

5 mV to 30 V Input Sensitivity:

0.003% to 10%, 6 ranges.

0.5 mV to 100 mV Input Sensitivity:

0.01% to 10%, 6 ranges.

#### Input Impedance:

300 k $\Omega$   $\pm$ 20%, unbalanced.

#### Display System:

RMS value (JIS).

Mean value (NAB).

Peak value (CCIR, DIN).

#### Display Accuracy:

$\pm$ 5% of full scale (at 4 Hz).

#### Frequency Response:

Weighted Characteristic:

In accordance with JIS, NAB, CCIR/DIN  
(at 0.2 Hz to 200 Hz).

Wow Characteristic:

0.5 Hz to 6 Hz (-3 dB  $\pm$ 1 dB) (JIS/NAB).

0.3 Hz to 6 Hz (-3 dB  $\pm$ 1 dB) (CCIR/DIN).

Flutter Characteristic:

6 Hz to 200 Hz (-3 dB  $\pm$ 1 dB).

#### Unweighted Characteristic:

0.5 Hz to 200 Hz (-3 dB  $\pm$ 1 dB) (JIS/NAB).

0.3 Hz to 200 Hz (-3 dB  $\pm$ 1 dB) (CCIR/DIN).

#### Roll Off:

JIS/NAB:

Below 0.5 Hz; more than -6 dB/octave.

Above 200 Hz; more than -15 dB/octave.

CCIR/DIN:

Below 0.3 Hz; more than -6 dB/octave.

Above 200 Hz; more than -15 dB/octave.

#### Maximum Input Voltage:

100 V (dc + ac peak).

#### Input Monitor:

LEVEL MONITOR indicator lights above input sensitivity  
threshold of 0.5 mV or 5 mV.

### FREQUENCY COUNTER SECTION

#### Measuring Frequency Range:

10 Hz to 9999 Hz.

#### Input level:

100 mV to 30 V rms.

#### Input Impedance:

300 k $\Omega$   $\pm$  20% (unbalanced).

#### Counting Capacity:

Decimal system, 4-digit LED memory display.

#### Reference Time:

Reference Time Frequency:

10.080 MHz (built-in crystal).

AC power frequency (AC line power).

## SPECIFICATIONS

---

### FREQUENCY COUNTER SECTION (Continued)

Reference Time Accuracy:

$\pm 5 \times 10^{-5}$ , 0 to  $+40^{\circ}$  C (built-in crystal).

AC power supply accuracy (AC line power).

**Gate Time:**

1 second.

**Measurement Accuracy:**

$\pm 1$  digit + reference time accuracy).

**Maximum Input Voltage:**

100 V (dc + ac peak).

**Input Monitor:**

LEVEL MONITOR indicator lights at more than 100mV of input (flickers at more than "9999 Hz" to indicate overrange condition).

### OUTPUT TERMINALS

**Recording Output Signal (OSC):**

Signal Frequency:

3 kHz, 3.15 kHz.

Accuracy:

$\pm 5 \times 10^{-5}$

Output Voltage:

0.2 V rms  $\pm 20\%$  (into open circuit).

Output Impedance:

600  $\Omega \pm 20\%$  (unbalanced).

Distortion Factor:

Less than 1% (600  $\Omega$  terminated).

**Drift Output Terminal (DRIFT):**

Output voltage:

Approx.  $\pm 1$  V dc for each  $\pm 1\%$  of frequency drift.

Output impedance:

600  $\Omega \pm 20\%$  (unbalanced).

**Scope Output Terminal (SCOPE):**

Output Voltage:

Approx. 3 V rms at full scale meter reading.

Output Impedance:

600  $\Omega \pm 20\%$  (unbalanced).

**Recorder Output Terminal (RECORDER):**

Output voltage:

Approx. 1 V dc at full scale meter reading.

Output impedance:

600 Ohm  $\pm 20\%$  (unbalanced).

### POWER REQUIREMENTS

**Voltage:**

AC 100/120/220/240V  $\pm 10\%$ , 50/60 Hz.

**Power Consumption:**

Approx. 14 Watts.

### MISCELLANEOUS

**Operating Temperature**

0 to  $+40^{\circ}$  C.

**Dimensions (HxWxD):**

Case Dimensions:

5-7/8 x 10-1/4 x 12-1/2" (150 x 260 x 318 mm).

Dimensions Including All Projections:

6-5/8 x 10-1/4 x 14-1/2" (170 x 260 x 370 mm).

**Weight:**

Approx. 11-3/4 lb (5.3 kg).

**Accessories Supplied:**

Input/Output Cable; dual banana plug to alligator clips.

Detachable AC Power Cord.

Instruction Manual.

Schematic Diagram & Parts List.

---

## CONTROLS AND INDICATORS

---

### FRONT PANEL CONTROLS Refer to Fig. 1.

1. **POWER Switch.** Pushbutton ON-OFF switch. Engaged position is **ON**, released position is **OFF**. When power is applied, the **FREQUENCY** display indicates "0000" (no input) and serves as a pilot light to show that the instrument is operating.
2. **OSCillator Switch.** Pushbutton switch selects **3 kHz (JIS-NAB-CCIR)** or **3.15 kHz (DIN)** at **OSC OUTPUT** terminals. Engaged position selects 3.15 kHz, released position selects 3 kHz.
3. **OSC OUTPUT Terminals.** Source of 3 kHz or 3.15 kHz (as selected by OSC switch) sine wave signal for recording wow and flutter test tape. Signal level is 200 mV rms into open circuit, output impedance is 600  $\Omega$ , distortion is less than 1%.

The **INDICATION** switches, items 4 thru 7, are mechanically interlocked so that only one may be engaged at a given time. Pressing a button releases the previous selection.

4. **JIS Switch.** Meter will indicate rms value of JIS standard (Japan).
5. **NAB Switch.** Meter will indicate mean value of NAB standard (U.S.A.).
6. **CCIR Switch.** Meter will indicate peak value of CCIR standard (France).

7. **DIN Switch.** Meter will indicate peak value of DIN standard (Germany).

The **FUNCTION** switches, items 8 thru 11, are mechanically interlocked so that only one may be engaged at a given time. Pressing a button releases the previous selection.

8. **WTD Switch.** Meter will indicate weighted combination of wow and flutter to selected JIS, NAB, CCIR, or DIN standard (0.2 Hz to 200 Hz frequency response).
9. **WOW Switch.** Meter will indicate wow component only (0.5 Hz to 6 Hz for JIS or NAB, 0.3 Hz to 6 Hz for CCIR or DIN).
10. **FLUTTER Switch.** Meter will indicate flutter component only (6 Hz to 200 Hz).
11. **UNWTD Switch.** Meter will indicate unweighted combination of wow and flutter (0.5 Hz to 200 Hz for JIS or NAB, 0.3 Hz to 200 Hz for CCIR or DIN).
12. **INPUT Terminals.** Input terminals for measuring wow and flutter; also input terminals to frequency counter. Maximum input voltage is 100 volts dc + ac peak, input impedance is 300 k $\Omega$ .
13. **SENSITIVITY Switch.** Pushbutton switch selects input level sensitivity for wow and flutter measurements. Engaged position is for 5 mV-30 V signal level at INPUT terminals. Released position is for 0.5 mV-100 mV signal level at INPUT terminals.

Insert Photo of B & K version with same callouts

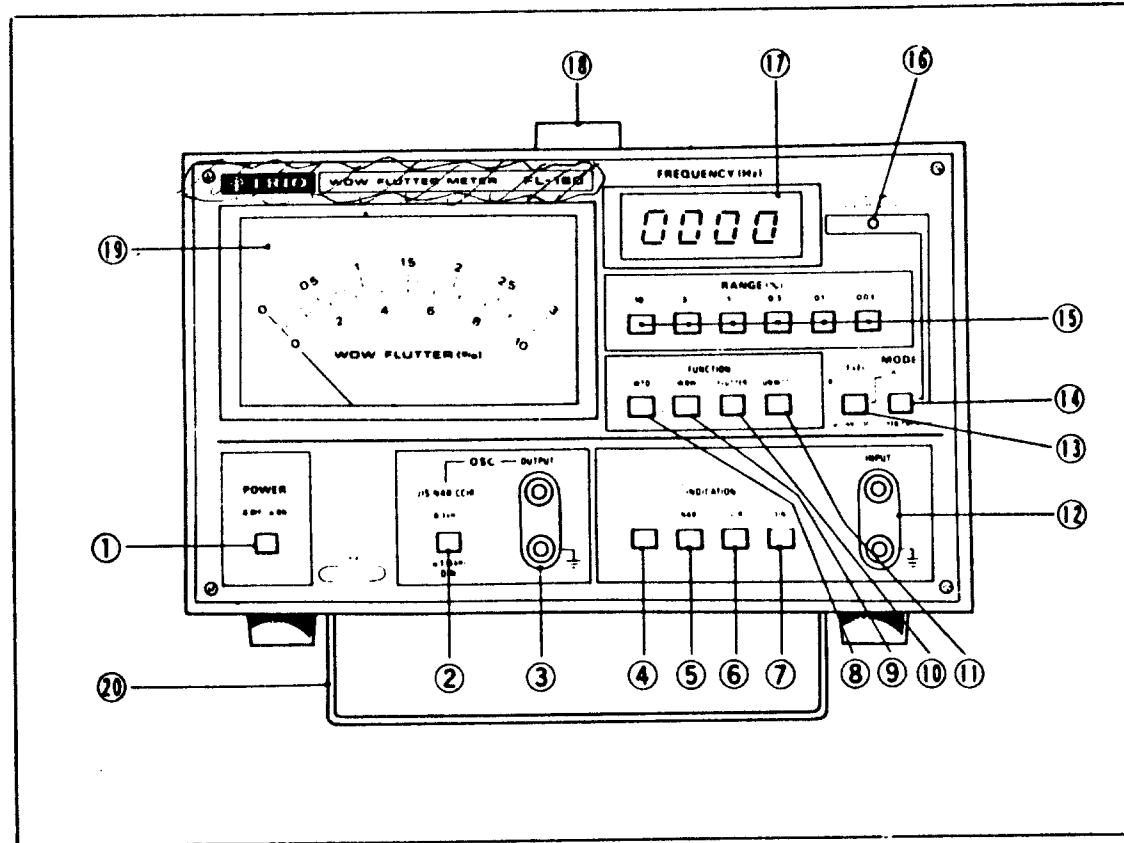

Fig. 1. Front Panel Controls and Indicators.



14. **WOW FLUTTER/FREQ COUNTER Switch.** Pushbutton switch selects mode of measurement. Released position is for **WOW FLUTTER** measurements. Engaged position is for **FREQ COUNTER** measurements; sensitivity becomes 100 mV to 30 V rms at **INPUT** terminals.
15. **RANGE (%) Pushbutton Switch Assembly.** Set of six interlocked pushbutton switches select meter range of **0.03%, 0.1%, 0.3%, 1%, 3%, or 10%** full scale. Use corresponding 0-3 or 0-10 scale of meter.
16. **LEVEL MONITOR Indicator.** In **WOW FLUTTER** mode, indicator will light when input signal is of adequate level (above sensitivity threshold of 0.5 mV or 5 mV, depending upon **SENSITIVITY** selection) and correct frequency (3 kHz  $\pm$ 300 Hz or 3.15 kHz  $\pm$ 300 Hz, depending upon **INDICATION** selection). In **FREQ COUNTER** mode, indicator will light when input signal is of adequate level (above 100 mV); indicator will flicker if frequency exceeds 9999 Hz as an overflow indication.
17. **FREQUENCY (Hz) Display.** Four digit LED display indicates the frequency of wow and flutter test signal being measured in **WOW FLUTTER** mode, or frequency of signal applied to **INPUT** terminals in **FREQ COUNTER** mode. Indicates "0000" with no input. The display always serves as a pilot light to show that the instrument is operating.
18. **Handle.**
19. **Meter.** Indicates wow and flutter in %. Two scales of 0 - 3 and 0 - 10 correspond to meter **RANGE** selection. Use **0 - 3** scale for 0.03%, 0.3%, and 3% ranges; use **0 - 10** scale for 0.1%, 1%, and 10% ranges.

20. **Tilt Stand** (Refer to Fig. 2). Elevates front of instrument for convenient viewing angle.

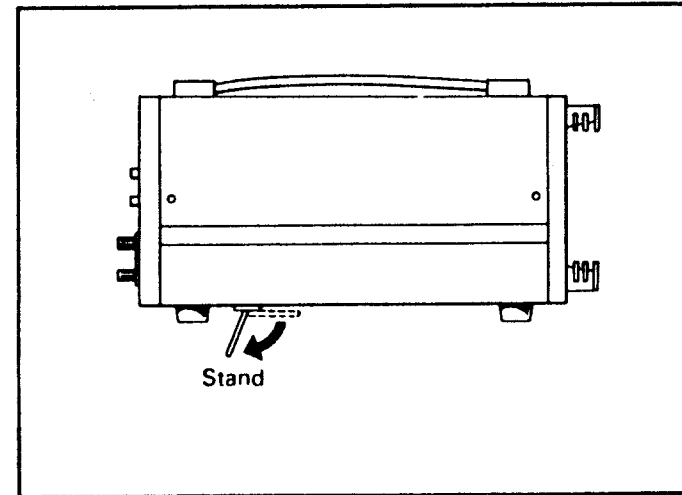
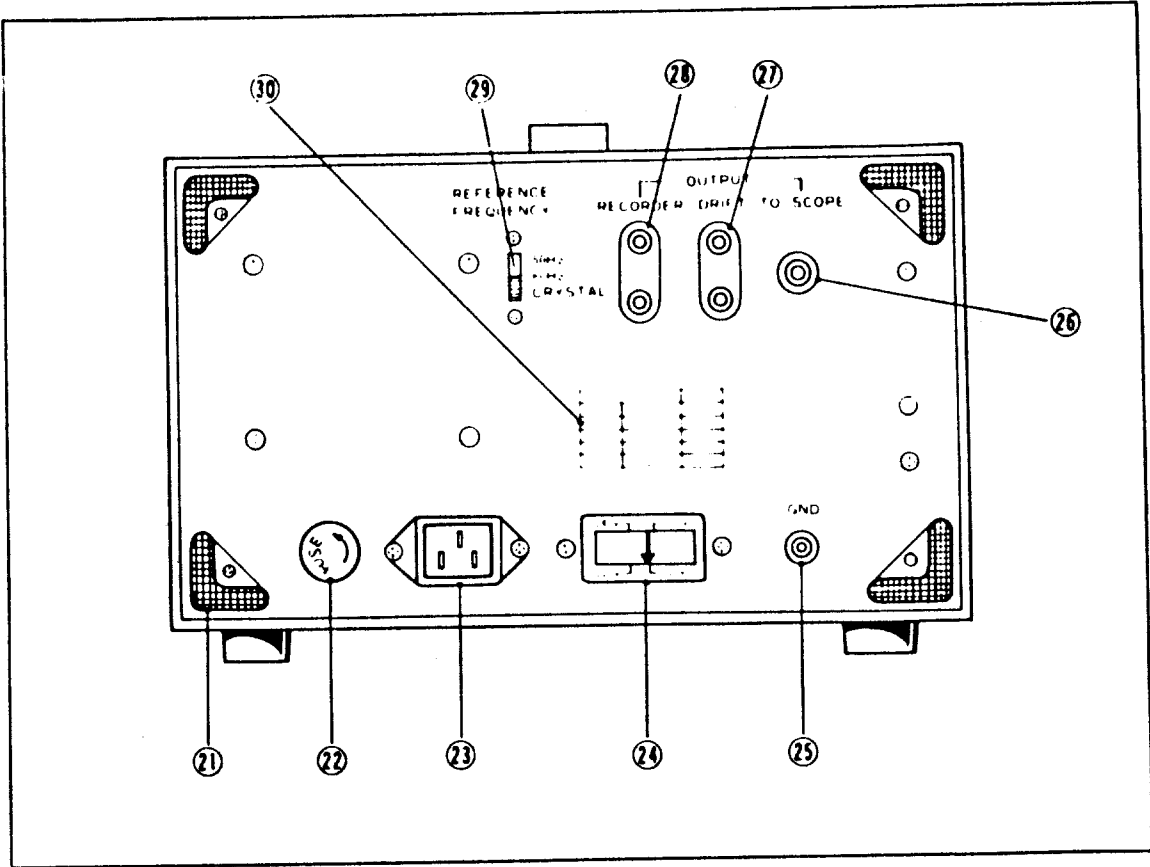

Fig. 2. Use of Tilt Stand.

**REAR PANEL FACILITIES** Refer to Fig. 3.

21. **Cord Wrap.** Stores power cord when not in use.
22. **Fuse Holder.** Use 0.5 A fuse for 100 or 117 VAC, 0.3 A for 220 or 240 VAC.
23. **Power Cord Receptacle.** Connector for detachable power cord.
24. **Line Voltage Selector.** Removable plug may be inserted four ways to select 100, 117, 220, or 240 V line voltage.

**CONTROLS AND INDICATORS**



**Fig. 3. Rear Panel Facilities.**

25. **GND Terminal.** Case ground and earth ground via power cord.
26. **TO SCOPE Terminal.** Provides ac output voltage proportional to wow and flutter indicated on meter, suitable for viewing on oscilloscope. Output voltage is 3 volts at full scale meter deflection, output impedance is 600  $\Omega$ .
27. **DRIFT Terminal.** Provides dc output voltage proportional to rotational speed error. Output voltage is  $\pm 1$  volt for  $\pm 1\%$  speed error.
28. **RECORDER Terminal.** Provides dc output voltage proportional to wow and flutter indicated on meter. Suitable for driving chart recorder. Output voltage is 1 volt for full scale meter deflection, output impedance is 600  $\Omega$ .
29. **REFERENCE FREQUENCY Switch.** Three-position slide switch selects reference frequency for frequency counter as follows:
- 50 Hz** Uses 50 Hz line frequency as reference.
  - 60 Hz** Uses 60 Hz line frequency as reference.
  - CRYSTAL** Uses internal crystal controlled oscillator as reference.
30. **Fuse Label.** Indicates line voltage limits and correct fuse value for each of 100, 117, 220, and 240 VAC line voltage.

---

## OPERATING INSTRUCTIONS

---

### SAFETY PRECAUTIONS

#### WARNING

*The following precautions must be observed to prevent electric shock.*

1. When this instrument is used with equipment that contains high voltage, there is always a certain amount of danger from electrical shock. The person using the instrument in such conditions should be a qualified electronics technician or otherwise trained and qualified to work in such circumstances. Observe the TEST INSTRUMENT SAFETY recommendations listed on the inside front cover of this manual.
2. The ground wire of the 3-wire ac power plug places the chassis and case of the instrument at earth ground. Use only a 3-wire outlet, and do not attempt to defeat the ground wire connection to float the instrument.
3. To test "hot chassis" equipment, always use an isolation transformer between the ac outlet and the equipment under test.
4. Always connect a cable from the GND terminal on the rear panel of this instrument to the chassis or common of the equipment under test.

5. Do not operate this instrument with the case removed unless you are a qualified instrument service technician. High voltage is present when the unit is operating with the case removed.

### EQUIPMENT PROTECTION PRECAUTIONS

#### CAUTION

*The following precautions will help avoid damage to the instrument.*

1. Excessive voltage applied to the INPUT jacks may damage the instrument. The maximum rating of the input is 100 V (dc + ac peak).
2. Never apply external voltage to output jacks.
3. Do not attempt to float the chassis and case reference of the instrument to a voltage point in the equipment under test; to do so may damage the instrument or the equipment under test.
4. The Line Voltage Selector must be set to match the ac line voltage being used. The correct fuse value is also dependent upon the ac line voltage. Follow the instructions in the LINE VOLTAGE SELECTION paragraph in this section of the manual.

**OPERATING TIPS**

*The following recommendations will help obtain the best performance from your wow and flutter meter.*

1. Use the cable supplied with the instrument, or if other cables are used, use shielded audio cable. Radiated noise may interfere with meter readings unless the input cable is well shielded, especially at low signal levels.
2. Connect the ground lead of the input cable to a signal ground reference point near the point of signal measurement.
3. Line voltage must be within  $\pm 10\%$  of specified nominal for accurate measurements.
4. The instrument and equipment under test must be free from external vibration for accurate measurements.
5. Avoid operation in high temperature and humidity when possible.

**LINE VOLTAGE SELECTION**

Before connecting the instrument to ac power the first time, check the line voltage selector on the rear panel. Make sure it is set for the line voltage you are using: 100, 117, 220, or 240 VAC, 50/60 Hz. Also make sure the correct value fuse is installed as follows:

- 0.5 A for 100 or 117 VAC line voltage.
- 0.3 A for 220 or 240 VAC line voltage.

**PREPARATION FOR OPERATION**

1. Connect detachable power cord to receptacle on rear panel and plug into ac outlet.

2. Turn **POWER** switch ON. **FREQUENCY (Hz)** display serves as pilot light; display indicates "0000" with no input.
3. Connect cable from **GND** terminal on rear panel of instrument to chassis or common of equipment under test.
4. Set controls to the following initial conditions:
  - a. **RANGE:** 1%.
  - b. **FUNCTION:** WTD.
  - c. **INDICATION:** as required (NAB in U.S.A.).
  - d. **SENSITIVITY:** 5 mV-30 V.
  - e. **Mode:** WOW FLUTTER

**WOW/FLUTTER MEASUREMENT**

1. Set **INDICATION** switch for desired type of measurement standard, JIS, NAB, CCIR, or DIN.
2. Use pre-recorded wow and flutter test tape or record or record a test tape as follows:
  - a. Connect cable from **OSC OUTPUT** terminals to input of recorder (see Fig. 4).
  - b. Set **3 kHz-3.15 kHz** switch to 3 kHz for JIS, NAB, or CCIR standards. Set to 3.15 kHz for DIN standards.
  - c. Remember that wow and flutter occurring during recording of the test tape will be present during playback, and added to the wow and flutter occurring during playback. Measured wow and flutter represents the total wow and flutter introduced

## OPERATING INSTRUCTIONS

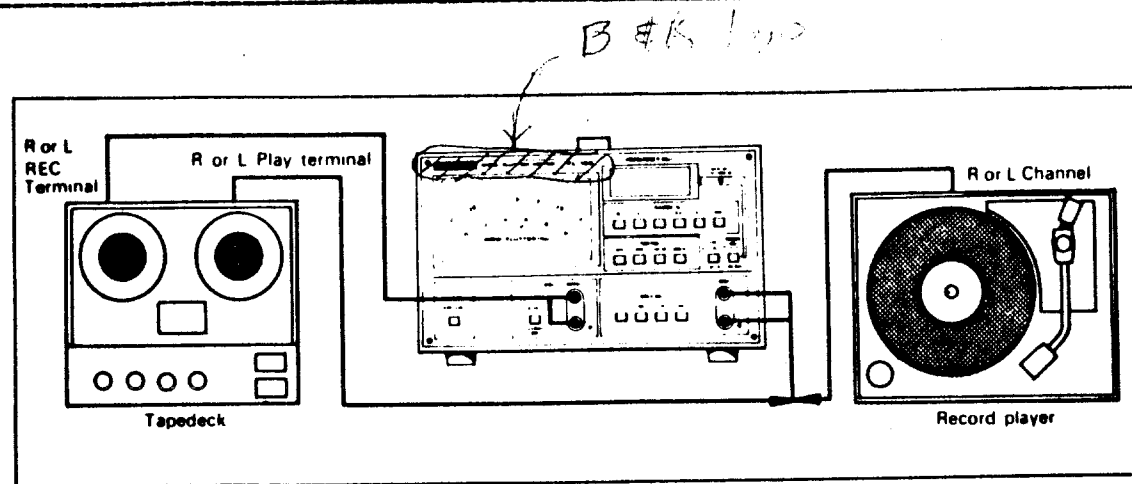

Fig. 4. Input and Output Connections to Wow & Flutter Meter.

- for record and playback. One half the measured value represents wow and flutter for playback only.
3. Connect output of equipment to be tested, such as tape recorder or turntable, to **INPUT** terminals (see Fig. 4).
4. **LEVEL MONITOR** indicator should light if signal is of adequate level and contains 3 kHz (JIS, NAB, or CCIR) or 3.15 kHz (DIN) test frequency. If **LEVEL MONITOR** indicator does not light, change **SENSITIVITY** switch setting to 0.5 mV-100 mV.
5. Confirm that the **FREQUENCY (Hz)** display indicates the wow and flutter test frequency (approximately 3000 or 3150 Hz). At high input levels, the **LEVEL MONITOR** indicator may light at frequencies other than 3 kHz or 3.15 kHz.
6. Set **FUNCTION** switch for desired frequency component:
  - WTD for weighted combination of wow and flutter (frequency response of 0.2-200 Hz).
  - WOW for wow component only; 0.5-6 Hz for NAB or JIS, 0.3-6 Hz for CCIR or DIN.
  - FLUTTER for flutter component only; 6-200 Hz.
  - UNWTD for unweighted combination of wow and flutter (0.5-200 Hz for NAB or JIS or 0.3-200 Hz for CCIR or DIN).
7. Set **RANGE** switch for highest obtainable meter reading without going off scale. Read percent of wow flutter from meter using a scale that corresponds to the range.

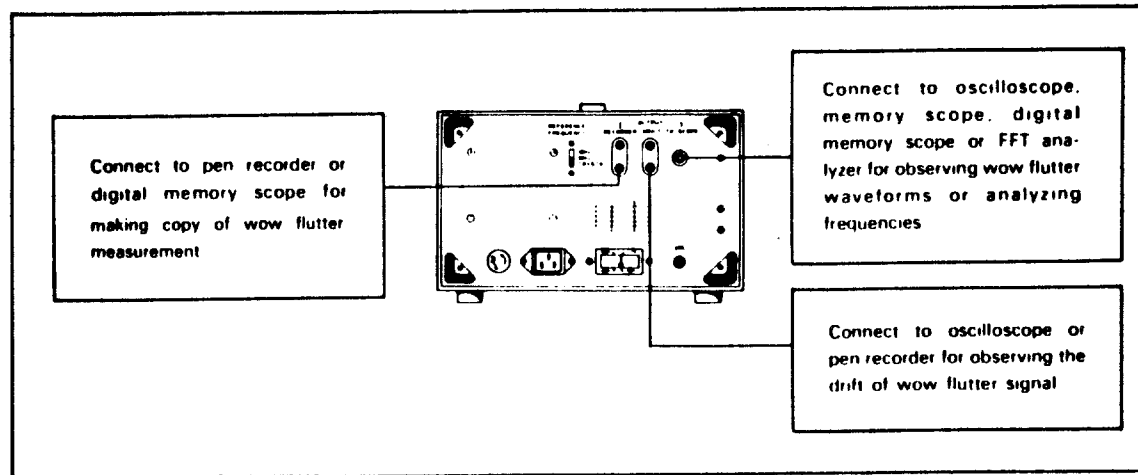

Fig. 5. Use of Terminals on Rear Panel.

**USE OF REAR PANEL TERMINALS** Refer to Fig. 5.

1. Connect **TO SCOPE** terminal to oscilloscope for observing wow and flutter waveform. Output is an ac voltage of approximately 3 volts rms at full scale meter deflection.
2. Connect **DRIFT** terminals to oscilloscope or chart recorder to observe drift or speed error. Output is a dc voltage (use dc coupling for oscilloscope input) of approximately 1 volt for each 1% of speed error.
3. Connect **RECORDER** terminals to digital memory scope or chart recorder for making a copy of wow and flutter measurements. Output is a dc voltage of approximately 1 volt for full scale meter deflection.

**USE AS FREQUENCY COUNTER**

1. Set Mode switch to **FREQ COUNTER** position and connect signal to be measured to **INPUT** terminals (see Fig. 6).
2. The input signal level must be 100 mV to 30 V rms. The **LEVEL MONITOR** indicator will light, indicating that adequate input signal level is applied.
3. Set the **REFERENCE FREQUENCY** switch of the rear panel to select the desired time base; 50 Hz line voltage, 60 Hz line voltage, or internal crystal controlled oscillator.
4. The frequency of the input signal will be displayed on the **FREQUENCY (Hz)** display. The counter is capable

## OPERATING INSTRUCTIONS

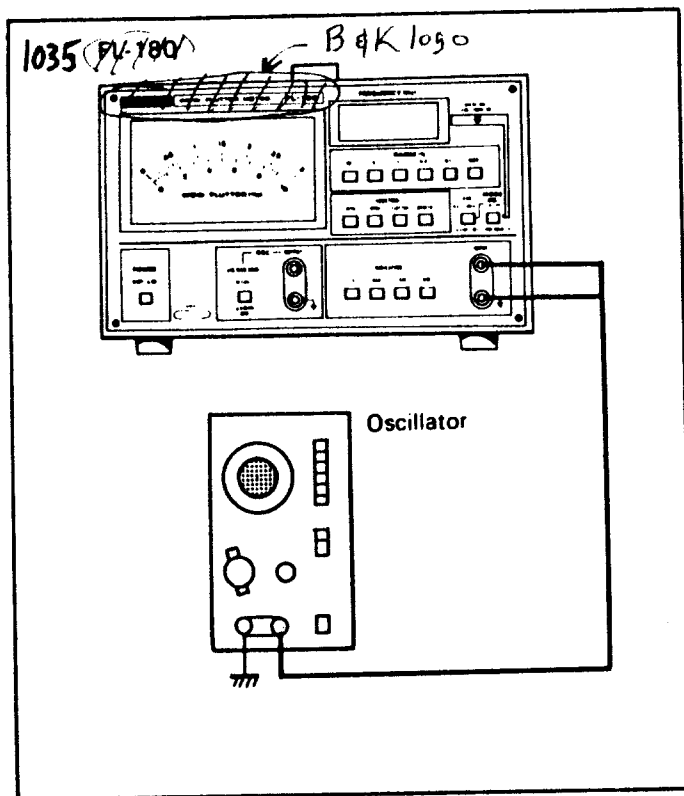

Fig. 6. Input Connections for Frequency Counter.

of displaying counts of 0000 to 9999 Hz. The **LEVEL MONITOR** indicator flickers above 10 kHz as an overflow indication. When the **LEVEL MONITOR** indicator is flickering, the most significant digit is not displayed. For example, if an input frequency of 13256 Hz is applied, the **LEVEL MONITOR** indicator flickers and the **FREQUENCY** display shows a count of 3256.

5. It is usually desirable to terminate the input signal into a 600  $\Omega$  or 50  $\Omega$  resistance (to match the output impedance of the signal source). This minimizes ringing or overshoot, especially when measuring square wave or rectangular wave signals.



---

## MAINTENANCE

---

### WARNING

1. The following instructions are for use by qualified service personnel only. To avoid electrical shock, do not perform servicing other than contained in the operating instructions unless you are qualified to do so.
2. A shock hazard is present when the case is removed if the power cord is plugged into an ac outlet. AC line voltage may be present on some circuits even when the POWER switch is off.

### CASE REMOVAL

Refer to Fig. 7. The case is constructed in two pieces. The top case may be removed by removing the two screws from the top and two screws from each side, then lifting the case upward by the handle. The bottom case may be removed by setting the instrument on the cord wrap/feet, removing the four screws from the bottom and pulling the bottom case away from the chassis.

### FUSE REPLACEMENT

Refer to Fig. 8. The fuseholder is mounted on the rear panel. Remove the fuseholder cap with a Phillips screwdriver and replace the fuse with the correct value as listed on the plate adjacent to the fuseholder.

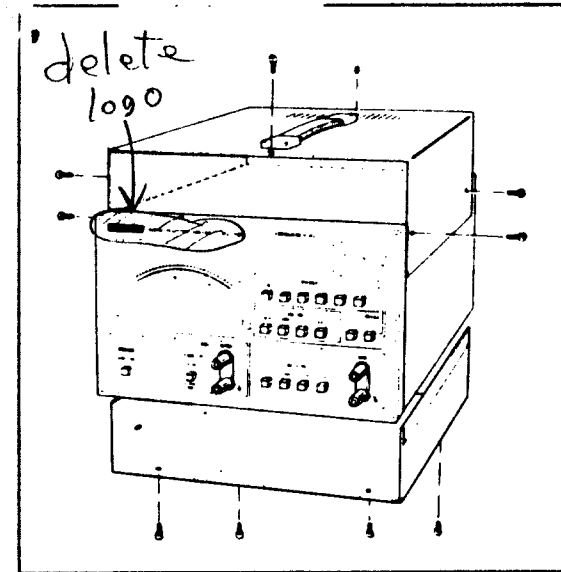

Fig. 7. Case Removal.

### ADJUSTMENTS

Refer to Fig. 8 for the locations of adjustments. The following offset balance adjustments may be performed using only an oscilloscope or accurate analog or digital multimeter. Other adjustments require a Wow & Flutter Meter Calibrator.

## MAINTENANCE

---

1. Turn on the instrument with no input applied. Make sure the LEVEL MONITOR lamp is off and the FREQUENCY (Hz) display is indicating "0000".
2. Connect a multimeter or oscilloscope using dc coupling to the DRIFT terminals. Adjust VR6 for 0 volts dc.
3. Connect the multimeter or oscilloscope to the RECORDER terminals. Adjust VR21 for 0 volts dc.
4. Connect the multimeter or oscilloscope to the TO SCOPE terminals. Adjust VR15 for 0 volts dc.

### INSTRUMENT REPAIR AND CALIBRATION SERVICE

This unit was carefully checked and calibrated at the factory prior to shipment. Readjustment is recommended only if repairs have been made in a circuit affecting calibration, or if you have reason to believe the unit may be out of calibration. Recalibration should be attempted only if you have the required test equipment. Recalibration of this instrument requires a Wow & Flutter Meter Calibrator. Very few instrument shops have such test equipment. If repair or recalibration is required, return the unit to the B & K-Precision Factory Service Department at Chicago. Also, if additional servicing information is required, contact the Factory Service Department.

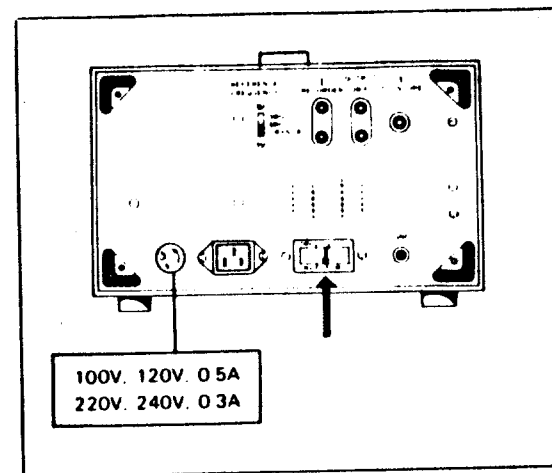

Fig. 8. Fuse Replacement.

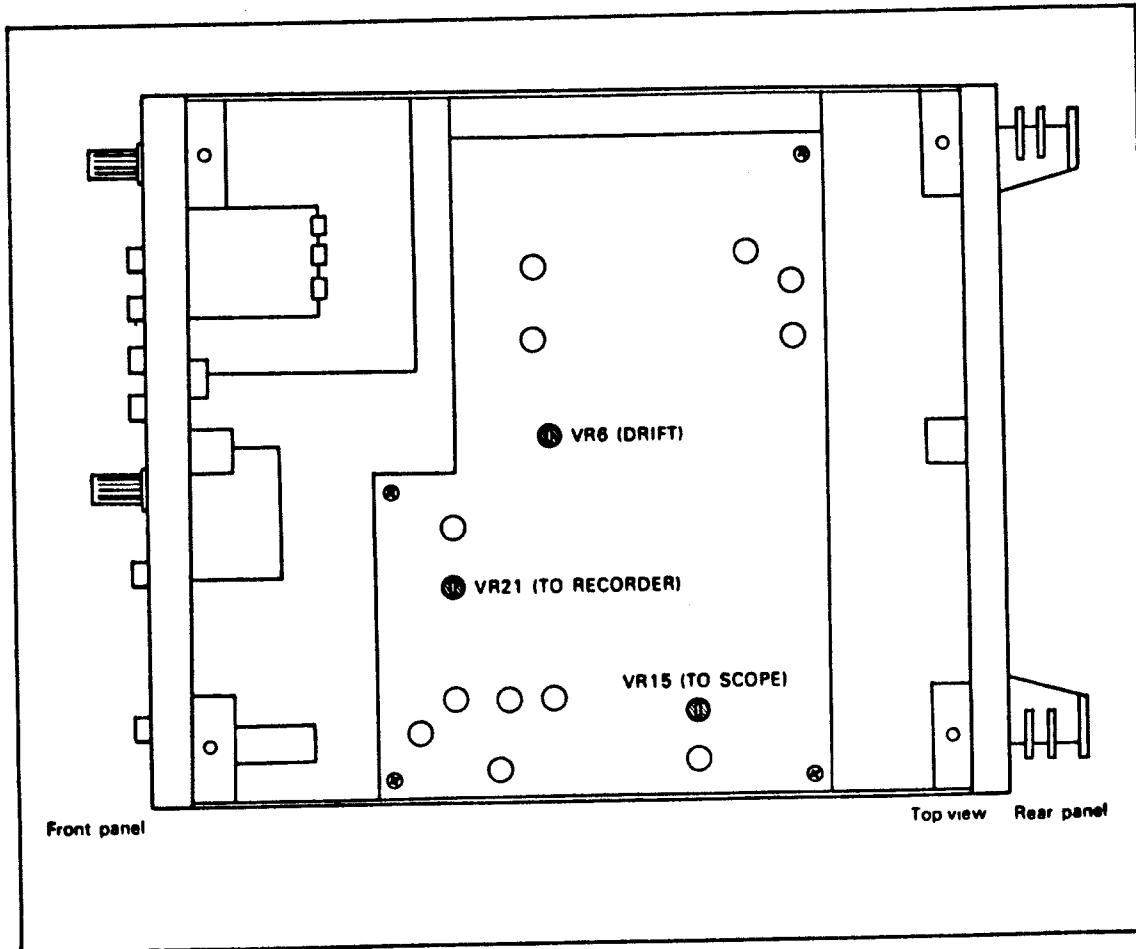

Fig. 9. Location of Adjustments.

---

**WARRANTY SERVICE INSTRUCTIONS**  
**(For U.S.A. and its Overseas Territories)**

---

1. Refer to the MAINTENANCE section of your **B & K-Precision** instruction manual for adjustments that may be applicable.
2. If the above-mentioned does not correct the problem you are experiencing with your unit, pack it securely (preferably in the original carton or double-packed). Enclose a letter describing the problem and include your name and address. Deliver to, or ship PREPAID (UPS preferred in U.S.A.) to the the factory service center at Chicago. Use the following address.

**B & K-Precision, Dynascan Corporation**  
Factory Service Operations  
4050 North Ravenswood Avenue  
Chicago, Illinois 60613  
Tel (312) 327-7270  
Telex: 25-3475

Also use this address for technical inquiries  
and replacement parts orders.