

Data sheet

1.44 kW Programmable DC Power Supplies

XLN Series



*) -GL version

New Family of High Density System Power Supplies

The B&K Precision XLN series are compact, programmable, single-output DC power supplies, suitable for a wide range of applications. Comparable supplies from other manufacturers primarily address the ATE market, while the XLN series are designed for both bench top users and system integrators.

For bench top applications, these power supplies offer built-in voltage and current meters displaying setting and output values concurrently, as well as an intuitive user interface with full keypad and rotary knob. Free application software is available to provide remote control capabilities without the need for any computer programming. Standard USB & RS485 and optional GPIB & LAN interfaces combined with fast average command processing times of less than 50 ms make the XLN series ideal for ATE applications. A complete set of LabVIEW™ drivers are also available to reduce programming time and increase productivity.

The XLN series provide clean power up to 1440 watts, with very low ripple and noise, in a compact 1U high 19 inch wide package. The supplies are perfectly suited for ATE systems integration, product design and development, product QC and burn-in testing, production, electro-plating and other applications requiring high power and a wide range of current and voltage ratings. When greater output power is required, up to four XLN models can be connected in either series or parallel and be synchronized with the RS-485 interface. Alternatively, the RS-485 interface can be used to daisy chain up to 31 units and to remotely control them from one master PC via USB, GPIB or LAN interface.

To protect your device(s) under test, the XLN series provide comprehensive safety options such as OVP, OCP, OPP, CV and CC protection as well as low input voltage protection. The supplies are designed to last and are backed by a two year warranty.



Features & Benefits

- Compact, high density, 1U package
- USB interface (standard) and GPIB & LAN (optional)
- External analog programming interface
- List mode: Execute 150 step test sequences from instrument memory
- Average command processing time < 50 ms
- Programmable voltage and current slew rate allow for "soft starting" of loads
- 5 V/1 A fixed output for auxiliary circuitry
- Built-in precise voltage and current measurements
- Internal memory stores up to 10 instrument settings
- Extensive protection features OVP, OCP, OPP and key-lock function
- Easy to configure master/slave mode for series & parallel connection of up to 4 units
- Control up to 31 power supplies from one PC via the RS485 interface
- Remote sense
- 100-240 V universal AC input with power factor correction
- High power output connector for quick and safe connectivity
- Timer-controlled output (1 s to 100 hr)
- Front to rear airflow allows for efficient cooling in high rack density environments
- LabVIEW™ drivers available

Selection Chart

	models			
	XLN3640	XLN6024	XLN8018	XLN10014
Output Voltage	0-36 V	0-60 V	0-80 V	0-100 V
Output Current	0-40 A	0-24 A	0-18 A	0-14.4 A
GPIB & LAN version	XLN3640-GL	XLN6024-GL	XLN8018-GL	XLN10014-GL

Interface

▲ Easy Front Panel Operation



The numeric keys and rotary knob provide a convenient interface for setting output levels quickly and precisely. Voltage and current can be set to a maximum resolution of 1 mV and 1 mA, respectively. Both meter values (measured output

values) and setting values are concurrently displayed on the screen. Additionally, the power supplies provide a memory space for storage of 10 instrument settings that can be set and recalled via both the front panel and remote interfaces.

▲ Rear Panel (-GL version shown with GPIB & LAN interface)

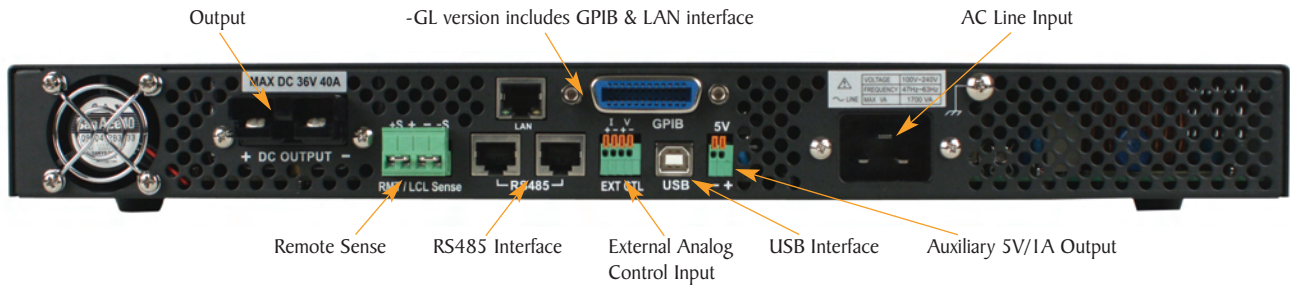

Rack Mount Kit (included)



Ears and Handles

Output Connectors (included)



Solder Type Terminal Block

Screw Type Terminal Block

Flexible Configuration

Master/Slave Operation

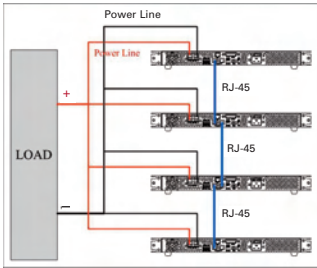

Parallel Configuration

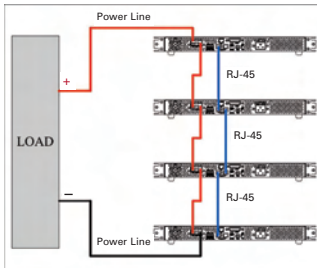

Series Configuration

Up to 4 units can be connected in parallel or series and operate in master/slave mode. The RS485 interface is used for communication between the master and slave(s). Once configured, the master will automatically search for and detect slave units and display the voltage and current of the complete system.

Multi-unit Control (up to 31 units)

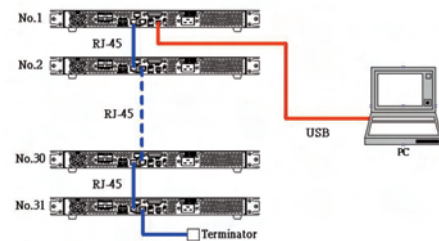

In multi-unit control mode, up to 31 units can be daisy chained via RS485 and controlled from one "master" unit via the USB interface (also GPIB and Ethernet).

Current Flow Timer for Breaker or Fuse Testing

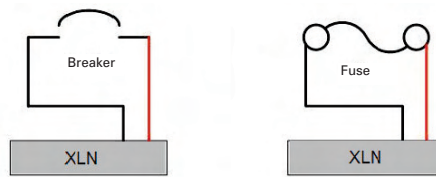

The XLN series can be used to accurately measure the time for a fuse or circuit breaker to open. After the voltage and current levels are set, the ON/OFF button turns on the output and the time when the fuse/breaker opens is measured to the nearest 100 μ s. The maximum counting period is one hour.

Remote Sense

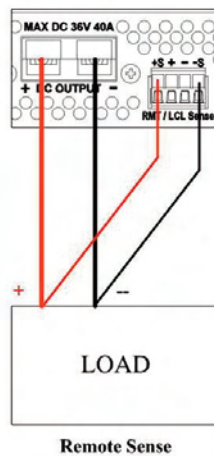

Remote Sense

The remote sense feature can compensate for up to 2 volts of voltage drop in the load wiring. Two small wires connect to the +S and -S sense terminals (high input impedance) and the power supply changes its output to make the voltage on these sense lines equal to the voltage set on the front panel.

External Analog Programming Interface

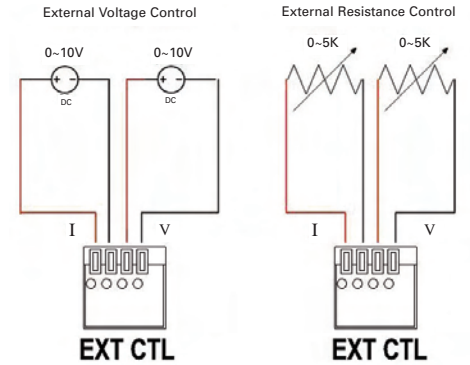

The output voltage and current can be controlled by either analog voltages or resistances. 0-10 V voltages and 0-5 k Ω resistances control from zero to full scale output.

Fixed 5V/1A Output

The XLN series offer an extra output with a constant output voltage of 5 VDC and a maximum output current of 1 A for powering an additional device. This output can be switched on or off in the "System Setting" menu.

Remote Access and Programming

System Integration

These power supplies offer standard USB and optional GPIB, Ethernet interfaces to facilitate test system development and integration. The XLN series support SCPI IEEE488.2 and come with LabVIEW™ drivers.

Test Sequence Execution in List Mode

The list mode feature allows users to download a list of commands to the power supply's internal memory and execute them. A total of 150 steps can be allocated to each internal memory location, up to a maximum of 10 locations. The test sequence can be programmed remotely via the USB, GPIB or LAN interfaces using SCPI commands or with the included application software. The test sequence can be configured for one time or repeated execution. Each step settings include voltage, current, and duration of the step (50 ms minimum).

Telnet Interface

The power supply can be controlled with SCPI commands via a Telnet connection over the Ethernet interface. Any computer with a Telnet client can be used to control the power supply.

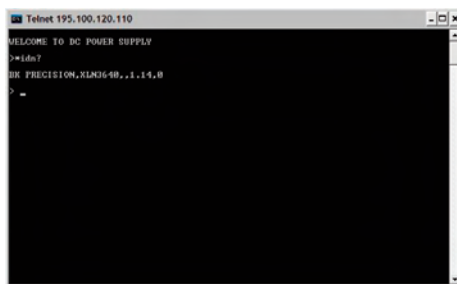

Application Software

Included with the power supply is a PC software for creating test sequences for execution in list mode via the GPIB or USB interface.

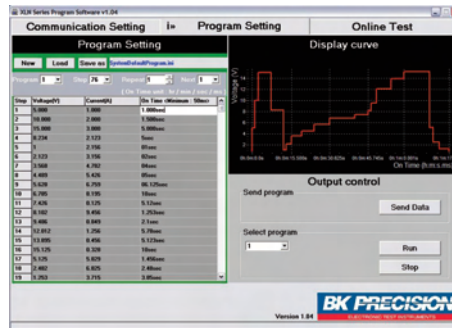

Create, save & load program lists. View output characteristic curves and export data to a file.

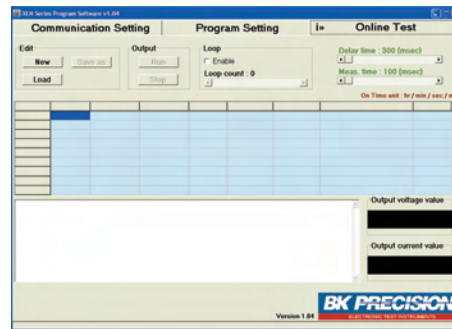

Pass/Fail test monitors maximum and minimum voltage and current values over a specified period of time.

Web Server Interface

XLN series power supplies with the -GL option (GPIB/LAN) provide a built-in Web Server. This allows users to configure, control or monitor the basic settings of the power supply from a remote computer using a Web browser such as Microsoft® Internet Explorer or Mozilla® Firefox. Connect to the user-defined IP address to view the welcome page (Compatible with Java-enabled browsers).

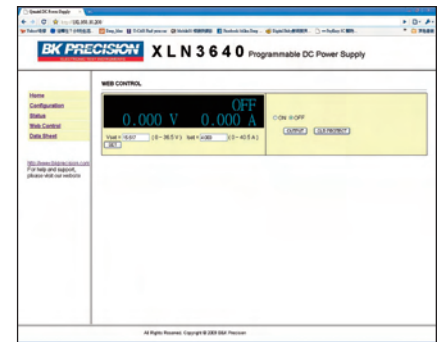

Interface for controlling voltage, current and output state

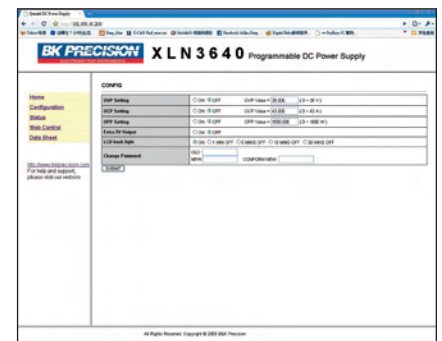

Setting Controls page for configuration of protection settings and setup/reset password for the system.

XLN Series - 1.44 kW Programmable DC Power Supplies
 Base models XLN3640, XLN6024, XLN8018, XLN10014 & -GL versions

Specifications	models			
	XLN3640	XLN6024	XLN8018	XLN10014
Output Rating				
Output Voltage	0-36 V	0-60 V	0-80 V	0-100 V
Output Current	0-40 A	0-24 A	0-18 A	0-14.4 A
Output Protection				
OVP Adjustment Range	2-38 V	3-64 V	4-85 V	5-105 V
OVP Accuracy	200 mV	300 mV	400 mV	500 mV
Line Regulation				
Voltage	≤ 4 mV	≤ 6 mV	≤ 8 mV	≤ 10 mV
Current	≤ 4 mA	≤ 4 mA	≤ 4 mA	≤ 4 mA
Load Regulation				
Voltage	≤ 8 mV	≤ 8 mV	≤ 10 mV	≤ 12 mV
Current	≤ 8 mA	≤ 7 mA	≤ 6.5 mA	≤ 6 mA
Ripple and Noise (20Hz-20MHz)				
Normal Mode Voltage (Load ≥ 0.5 % of max load)	≤ 5 mVrms/≤ 60 mVpp	≤ 6 mVrms/≤ 70 mVpp	≤ 7 mVrms/≤ 80 mVpp	≤ 8 mVrms/≤ 80 mVpp
Normal Mode Current	≤ 90 mA	≤ 70 mA	≤ 50 mA	≤ 40 mA
Programming Resolution				
Programming & Readback	1 mV/1 mA	1.5 mV/1 mA	2 mV/1 mA	2.5 mV/1 mA
Programming Accuracy (% output+offset)				
Voltage	0.05 %+10 mV	0.05 %+15 mV	0.05 %+20 mV	0.05 %+25 mV
Current	0.05 %+10 mA	0.05 %+18 mA	0.05 %+7 mA	0.05 %+6 mA
Readback Accuracy (% output+offset)				
Voltage	0.05 %+10 mV	0.05 %+15 mV	0.05 %+20 mV	0.05 %+25 mV
Current	0.05 %+10 mA	0.05 %+18 mA	0.05 %+7 mA	0.05 %+6 mA
General				
Average Command Response Time	≤ 50 ms			
Power Factor Correction (PFC)	≥ 0.99 (Full load)			
Efficiency	80% (Full load)			
Remote Sense Compensation	2 V			
Rise Time at Full & No Load	≤ 15 ms	≤ 20 ms	≤ 25 ms	≤ 30 ms
Fall Time at Full/No Load	≤ 15 ms/≤ 1000 ms	≤ 20 ms/≤ 1000 ms	≤ 25 ms/≤ 1000 ms	≤ 30 ms/≤ 1000 ms
Transient Response Time	≤ 1 ms			
AC Line Rated Input Voltage/Hz	100-240 VAC / 47 Hz-63 Hz			
Tolerance/Variation in Voltage	-15 % to +10 % (10 % power de-rating mode when voltage under 95 Vac)			
Maximum Rated Input Power	1700 VA			
Temperature Ratings	Operation (0 °C - 40 °C) / Storage (-10 °C - 70 °C)			
Standard Interface	USB			
Optional Interface	LAN & GPIB			
Dimensions(W*H*D)	16.5 x 1.7 x 17 inch (420 x 43.6 x 432 mm)			
Weight	19.8 lbs. (9 kg)			
Two Year Warranty				
Supplied Accessories: Power Cord, Terminal Blocks for Rapid Plug Connector, Rackmount Kit, Certificate of Calibration and Test Report, User Manual				